

# Antares T60

## Operating and installation instructions



# EQUIPMENT ILLUSTRATION

---

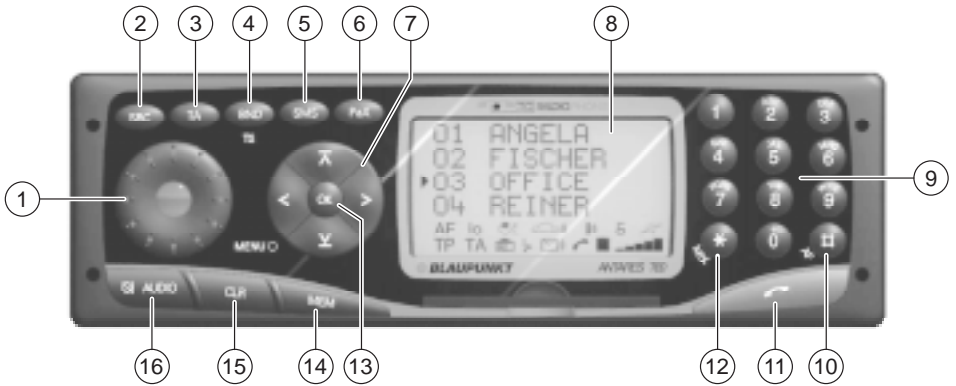

- ① Volume control, on/off switch
- ② **SRC** button, source selection between radio, CD changer (if connected) or auxiliary equipment/AUX (if connected)  
Switch from telephone to radio or CD changer operation (CD changer optional)
- ③ **TA** button, on/off switch for traffic announcement priority
- ④ **BND** button, to select the FM memory banks and the MW and LW wavebands  
To activate the Travelstore function  
To switch from handset to hands-free telephone operation (handset optional)
- ⑤ **SMS** button, to retrieve new SMS messages
- ⑥ **PaX** button, to activate preset function
- ⑦ Multifunctional rocker switch
- ⑧ Display
- ⑨ Numbers buttons **0 - 9**
- ⑩ **#/AF** button, to switch RDS convenience functions on/off
- ⑪ Telephone button
- ⑫ **\*/MIX** button, to adjust station seek tuning sensitivity  
To play CD titles in random order
- ⑬ **OK** button, to access the DSC menu and submenu items, to confirm settings
- ⑭ **MEM** button, list of radio stations stored in the memory, to display CDs in the unit and telephone book entries
- ⑮ **CLR** button, clear (delete) and back button
- ⑯ **AUDIO** button, to adjust tone and balance/fader,  
To switch Loudness on/off  
Microphone mute

## Radiophone Antares T 60 - and you can be sure safety is first

Because the Antares T 60 is the symbiosis consisting of a powerful GSM mobile telephone with full-duplex hands-free operation and an excellent audio system with a digital tuner and CD changer option.

When the quality of your in-car telephone and road safety are important issues, the Antares T 60 makes no compromises. And that's to your advantage.

And if you want to be absolutely sure that safety is first, leave your hands where they belong - on the steering wheel.

VOCS 08, the optional voice control system, the TH 07 handset and the RCT 07 steering wheel remote control unit transform the Antares T 60 into one of the safest mobile telephones on the market.

So, have fun paging through and reading this manual. Take some time and get acquainted with your new Radiophone.

# CONTENTS

---

<b>Radiophone Antares T 60 - and you can be sure safety is first .....</b>	<b>3</b>	<b>Radio operation .....</b>	<b>15</b>
<b>Safety information .....</b>	<b>7</b>	Selecting the radio mode .....	15
Safety standards .....	8	RDS convenience functions (AF, REG) .....	15
Installation .....	8	Selecting the memory bank/waveband .....	16
Accessories .....	8	Selecting a radio station .....	16
SIM card .....	8	Paging through station networks .....	16
<b>Operating the Radiophone .....</b>	<b>9</b>	Storing stations manually .....	16
Audio operation (without the telephone) .....	9	Storing the stations with the strongest signals automatically (Travelstore) .....	17
For audio and telephone operation .....	9	Recalling stored stations .....	17
Removing the SIM card .....	9	Switching between stereo and mono ..	17
Switching the Radiophone on/off with the vehicle ignition .....	9	Selecting Radiotext display .....	17
Switching on the Radiophone when the ignition is switched off .....	10	<b>Traffic radio reception .....</b>	<b>18</b>
Switching the Radiophone on after the unit has been disconnected from its power supply .....	10	Switching priority for traffic announcements on/off .....	18
<b>Basic functions .....</b>	<b>10</b>	<b>CD changer operation .....</b>	<b>18</b>
Selecting the audio mode .....	10	Selecting the CD changer mode .....	18
Direct access to functions (PaX) .....	10	Selecting a CD .....	18
Controlling/adjusting the volume .....	11	Selecting a track on a CD .....	18
Tone and balance/fader .....	12	Fast Cue/Review (audible) .....	18
Loudness .....	12	Playing tracks in random order (MIX) ..	19
Adjusting brightness, colour and legibility .....	13	Displaying the list of CDs in the changer .....	19
Selecting the system language .....	13	Naming CDs .....	19
Optical theft protection .....	14		
Changing the DSC access code .....	14		
Resetting personal settings .....	14		
Connecting auxiliary equipment .....	14		
CODE theft protection .....	15		

<b>General information .....</b>	<b>21</b>	Selecting the phone number from the list of missed calls .....	28
Emergency call .....	21	Selecting the phone number from the list of calls received .....	28
<b>Starting telephone operation ....</b>	<b>21</b>	Deleting an entry from the incoming/ outgoing call list .....	28
Selecting the telephone mode .....	21	Deleting the incoming/outgoing call list	28
Inserting the SIM card .....	21	Answering a call .....	28
Entering the PIN code .....	21	Automatic answer .....	29
Switching the PIN code on/off .....	22	Rejecting a call .....	29
Changing the PIN code .....	22	Switching the microphone to mute ...	29
Unblocking the SIM card .....	23	Switching off the mute function .....	29
<b>Basic functions .....</b>	<b>23</b>	Redial .....	29
Adjusting the volume .....	23	Automatic redial .....	29
Adjusting the ringing tone volume .....	23	Ending the automatic redial function ....	29
Adjusting the hands-free volume .....	24	Call waiting (2nd call on hold) .....	29
Adjusting the handset volume (handset optional) .....	24	Answering the 2nd call .....	29
Traffic announcements (TA) during hands-free operation .....	24	Rejecting the 2nd call .....	29
Selecting the ringing tone .....	25	Hold/broker's calls .....	30
<b>Service functions .....</b>	<b>25</b>	Hold .....	30
Audible call timer .....	25	Broker's calls .....	30
Setting the timer .....	25	Conference calls .....	30
Displaying call charges/time .....	26	Ending a conference call .....	30
Resetting the counter .....	26	Notebook function .....	30
Setting the Charges, Time display during a call .....	26	Foreign calls .....	30
<b>Using the telephone .....</b>	<b>27</b>	What do you have to do before travelling to a foreign country? .....	31
Dialing phone numbers .....	27	How do I place a telephone call to a foreign country? .....	31
Manual dialing .....	27	How can I be reached? .....	31
One-touch dialing (from the Radio- phone memory) .....	27	How do I call a wired network telephone number in the foreign country? .....	31
Speed-dial (from the SIM card memory) .....	27	Selecting a network .....	31
Selecting a number from the phone book .....	27	Displaying the available networks .....	31
Finding an entry by name .....	27	Adjusting the network search method ..	31
Selecting the phone number from the list of last numbers dialed .....	28	Editing the network list .....	32
		Adding a GSM network to the list .....	32
		Moving an entry on the list .....	32
		Deleting an entry on the list .....	32

# CONTENTS

---

Call forwarding .....	32	<b>Messages (SMS) / Mailbox .....</b>	<b>38</b>
Registering call forwarding .....	33	Reading new messages .....	38
Activating call forwarding .....	33	Sending messages .....	38
Deactivating call forwarding .....	33	Entering the service number .....	38
Displaying call forwarding status .....	33	Setting message validity .....	39
Deleting individual call forwarding		Reading old messages .....	39
functions .....	33	Deleting messages .....	39
Deleting all the call forwarding		Mailbox (Mobile box) .....	39
functions .....	33	Entering the mailbox phone number /	
Call barring .....	33	calling the mailbox .....	39
Activating call barring .....	33	Cell broadcast messages .....	40
Deactivating call barring .....	34	<b>Special functions .....</b>	<b>40</b>
Displaying call barring status .....	34	Determining the user group .....	40
Changing the password for call		Switching user group on/off .....	40
barring .....	34	Entering AOC parameters .....	40
Locking the Phone .....	34	<b>Specifications .....</b>	<b>41</b>
Switching on the phone lock .....	34	Amplifier .....	41
Switching off the phone lock .....	34	Tuner .....	41
<b>Phone book .....</b>	<b>35</b>	Telephone .....	41
Entering names and telephone		<b>Operating the Radiophone with</b>	
numbers .....	35	<b>the RCT 07 remote control unit</b>	
Moving the input cursor .....	35	<b>(optional) .....</b>	<b>42</b>
Deleting entries .....	35	Radio operation .....	42
Adding characters .....	35	Telephone operation .....	42
Storing names / telephone numbers	35	CD changer operation (optional) .....	42
Finding entries .....	36	<b>Telephone menu overview .....</b>	<b>43</b>
Editing entries .....	36	<b>Radio menu overview .....</b>	<b>47</b>
Changing an entry .....	36	<b>Glossary of Technical Terms .....</b>	<b>49</b>
Deleting an entry .....	36	<b>Installation instructions .....</b>	<b>52</b>
Moving an entry in the phone book .....	36		
Copying an entry in the phone book .....	36		
Capacity query .....	37		
Locking/unlocking access to the			
phone book .....	37		
Locking the phone book .....	37		
Unlocking the phone book .....	37		
Entering your own phone number .....	37		

## Safety information

### Traffic safety

Traffic safety always has the highest priority.

As the driver of a motor vehicle, it is your responsibility to pay attention to the traffic situation at all times. Never use your car radio in a way that could distract you.

Please keep in mind that you travel a distance of 14 m per second at a speed of only 50 km/h.

Should the traffic situation become particularly demanding, we advise you not to use this equipment.

Always make sure that you are still able to hear any warning signals coming from outside of your vehicle, such as police or fire engine sirens, so that you can react accordingly.

Consequently, you should always select a moderate volume for playing your car audio equipment while you are driving.

### Using the telephone while driving

Please observe all laws and regulations regarding the use of mobile telephones in motor vehicles.

- Concentrate fully on your driving.
- Stop at a safe place before using the telephone.
- If otherwise unavoidable:  
Use only hands-free operation if you have to use the telephone while you are driving.

Traffic safety always has the highest priority.

### Using the telephone in critical areas

Always switch off the mobile telephone in areas where it is forbidden to use a mobile phone or if this equipment could cause electromagnetic interference or otherwise dangerous situations.

Using the telephone can result in interference with the correct functioning of medical equipment that is not sufficiently shielded, particularly near the antenna. Please consult a doctor or the manufacturer of the medical device if you have any questions. Other electronic equipment can also be affected by electromagnetic interference.

If you are in an area where there is danger of explosion, e.g. filling stations, chemical factories or places where blasting work is being done, switch your telephone off.

### Emergency calls

As with every other mobile telephone, the Radiophone operates using a combination of mobile radio and cross-country networks, radio signals and functions programmed by the user. As a result, there is no guarantee that your call will always go through. Never depend exclusively on a mobile telephone or similar equipment under life-threatening circumstances (e.g. in medical emergencies).

The telephone interface of the Radiophone is only able to make and receive calls when it is activated, located in an area served by a GSM 900 radio network and when the signal is strong enough.

Emergency calls may not be possible on all mobile telephone networks or only if certain network services and/or certain performance features are active. Contact the local network operators for more detailed information.

Please read this instruction manual for further information and consult your local service provider.

When placing an emergency call, be sure to supply all the necessary information as accurately as possible. Remember that your mobile telephone may be the only means of communication at the scene of an accident.

# IMPORTANT INFORMATION

---

Do not hang up until you are told to do so.

Also read the information in the section on "Telephone operation - GSM emergency calls".

## Safety standards

The mobile telephone has been manufactured in accordance with all of the applicable radio frequency (RF) safety standards and recommendations determined by the government offices and organisations responsible (e.g. the VDE standard DIN-0848).

## Installation

Only a trained service technician is authorised to install and service the Radiophone in your vehicle. Faulty installation or servicing can be dangerous and will result in the expiry of your guarantee.

This equipment must not be operated without a suitable GSM or combination antenna mounted on the outside of the vehicle. The equipment including the GSM or combination antenna must be installed by an authorised Bosch service centre only.

To ensure trouble-free operation, the positive power supply line must be connected via the ignition and the permanent +12 V lead.

Do not ground the speaker outputs!

## Accessories

Use Blaupunkt-approved accessories and spare parts only.

You can use the following Blaupunkt products with this equipment:

### CD changers

The Blaupunkt CDC A 08 and the IDC A 09 CD changers can be connected to the Radiophone.

### Remote control

Using the RCT 07 infrared remote control (7 607 570 510) you can conveniently control all of the most important functions of your Radiophone from the steering wheel.

### Handset (telephone receiver)

With the TH 07 Blaupunkt handset (7 607 570 512) it is possible to place telephone calls with or without using the hands-free function. The system will switch automatically from hands-free to handset operation when the handset is removed from the cradle.

 There is a relatively strong magnet in the handset.

Keep everything that could react adversely to magnetic fields well away from the handset. This includes diskettes, check cards, etc. Important data may be deleted.

### Amplifiers

All Blaupunkt amplifiers

### Voice control system

(Available for German only)

Using the VOCS 08 voice control system, you can control the most important system functions by speaking certain commands aloud in German.

Because the motorist is subjected to a minimum amount of distraction when operating the equipment using a voice control system, this feature makes an important contribution to road safety.

### SIM card

This Radiophone has been equipped for telephone operation using modern 3-V SIM cards. Please ask your dealer for more information.



## Operating the Radiophone

### Audio operation (without the telephone)

- ◇ Press **ON**.

#### Note:

If the card tongue is not pushed in when you switch on the unit, the Radiophone will switch off again automatically after 15 seconds.

If you push the card tongue in within the first 15 seconds, the Radiophone will not switch off.

When you switch on the Radiophone for the first time,

- ◇ enter the four-digit safety code in the radio pass using the **0 - 9** buttons.

If you enter an incorrect digit,

- ◇ press **CLR** to delete the digit.
- ◇ Press **OK** to confirm the code.

### For audio and telephone operation

With the card tongue pushed in,

- ◇ press the card tongue gently in the direction of the Radiophone until you feel slight resistance.
- ◇ Release the card tongue.

The card tongue will now eject from the Radiophone.

- ◇ Lay the SIM card on the card tongue with the **chip facing upwards and towards the Radiophone** and push it into the slot until you feel slight resistance.
- ◇ Press the SIM card gently down at the back onto the card tongue so that it is lying completely on the card tongue.
- ◇ Push the card tongue into the Radiophone gently until you feel slight resistance and you **hear** the card tongue click into position.

The Radiophone will switch on. If the PIN inquiry has been activated, **ENTER PIN** will

appear in the display. Also refer to "Switching the PIN code on/off".

### Removing the SIM card



**Never just pull out the SIM card. You could destroy it.**

- ◇ Push the SIM card in gently, towards the Radiophone.

The card tongue holding the SIM card will eject.

- ◇ Remove the SIM card.

### Switching the Radiophone on/off with the vehicle ignition

- ◇ When the Radiophone is on, switch off the vehicle ignition and remove the ignition key.

The Radiophone will switch off.

- ◇ Switch on the ignition.

The Radiophone will switch on if you switched it off with the vehicle ignition.

#### Note:

If the ignition timer is switched on, the Radiophone will not switch off until after the time set has elapsed.

If the SIM card is still in the Radiophone when it is switched off, you will hear two beeps.

If the ignition is switched off during a telephone call, the Radiophone will remain switched on until the telephone call has been completed.

### Set the ignition timer

You can set the ignition timer to determine whether and how long the Radiophone should continue to play after the ignition has been switched off.

- ◇ If you are in telephone mode, press the **SRC** button to switch to radio operation.
- ◇ Press **OK** to access the DSC menu.
- ◇ Use **▲/▼** to select the menu item **Setup**.
- ◇ Press **OK**.
- ◇ Press **▲/▼** to select the menu item **Ignit. timer**.

- ⇨ Press **OK**.
- ⇨ Press **</>** to select the desired setting from between **0** (no delay) and **90 min**.
- ⇨ Press **OK**.
- ⇨ Press **SRC** to exit the DSC menu.

### Switching on the Radiophone when the ignition is switched off

- ⇨ Press **ON**.

The Radiophone will switch on.

To avoid running down the battery, the Radiophone will switch off again automatically after one hour.

### Switching the Radiophone on after the unit has been disconnected from its power supply

If the Radiophone has been disconnected from the battery (e.g. when the vehicle is being repaired) and is reconnected, you will be required to enter the security code in the radio pass the first time you switch it on again.

## Basic functions

### Selecting the audio mode

You can switch between radio, CD changer operation and the operation of an auxiliary audio source (if connected).

- ⇨ Press **SRC** repeatedly until the functions for the operating mode you want to select appear in the display.

### Direct access to functions (PaX)

You can program the **PaX** button with **one** function you use frequently for direct access.

Select one of the following functions:

- Radiotext
- Telephone number
- Mailbox
- Send SMS
- Network selection
- Call forwarding
- Telephone book

#### Note:

You can change the function you have selected for the **PaX** button at any time.

### Programming the PaX button

- ⇨ Press and hold down the **PaX** button for longer than one second.

The list of available functions will appear in the display. If the **PaX** button has already been programmed, the cursor will indicate the function currently selected.

- ⇨ Press **↓/↵** to select the desired function.
- ⇨ Press **OK**.

**PaX program. finished** will appear in the display.

The main telephone menu will now appear in the display. The **PaX** button is ready to use.

## Activating the PaX function

To activate the function you have programmed on the **PaX** button,

- ⇨ press the **PaX** button briefly.

## Controlling/adjusting the volume

### Controlling the system volume

Once the Radiophone has been switched on, it will play at the pre-defined power-on volume.

- ⇨ To increase the system volume, turn the volume control to the right.
- ⇨ To decrease the system volume, turn the volume control to the left.

The volume level selected will appear in the display.

### Adjusting the power-on volume (Volume FIX)

- ⇨ Press **OK** to access the DSC menu.
- ⇨ Press **↔** to select the menu item **Radio**.
- ⇨ Press **OK**.
- ⇨ Press **↔** to select the menu item **Volume FIX**.
- ⇨ Press **OK**.
- ⇨ Press **↔** or turn the volume control knob to adjust the Radiophone to the desired power-on volume level.
- ⇨ Press **OK**.
- ⇨ Press **SRC** to exit the DSC menu.

If you select the **Last Volume** option, the power-on volume will be the volume last set before the Radiophone was switched off.

### Adjusting the beep volume

You will hear a beep whenever you activate functions that require you to press a button for longer than one second.

You can set the beep volume to a level from 0 to 9.

- ⇨ Press **OK** to access the DSC menu.
- ⇨ Press **↔** to select the menu item **Setup**.
- ⇨ Press **OK**.
- ⇨ Press **↔** to select the menu item **Beep**.
- ⇨ Press **OK**.
- ⇨ Press **↔** to adjust the Radiophone to the desired volume level.
- ⇨ Press **OK**.
- ⇨ Press **SRC** to exit the DSC menu.

### Adjusting the volume for traffic announcements (TA Volume)

You can adjust the volume for traffic announcements and for the message that there is no traffic radio station currently available. The traffic announcement will be broadcast at this volume, even if the system volume is lower.

- ⇨ Press **OK** to access the DSC menu.
- ⇨ Press **↔** to select the menu item **Radio**.
- ⇨ Press **OK**.
- ⇨ Press **↔** to select the menu item **TA volume**.
- ⇨ Press **OK**.
- ⇨ Press **↔** or turn the volume control knob to adjust the Radiophone to the desired volume level.
- ⇨ Press **OK**.
- ⇨ Press **SRC** to exit the DSC menu.

# BASIC FUNCTIONS

---

## Tone and balance/fader

### Treble

- ⇨ Press **AUDIO**.
- ⇨ To adjust the treble, press **T** or **V**.

### Bass

- ⇨ Press **AUDIO**.
- ⇨ To adjust the bass, press **<** or **>**.

### Balance

- ⇨ Press **AUDIO** twice.
- ⇨ To adjust the balance between the left/ right speakers, press **<** or **>**.

### Fader

- ⇨ Press **AUDIO** twice.
- ⇨ To adjust the fader between the front/ rear speakers, press **T** or **V**.

To exit the Audio menu, press **AUDIO** again. Or, after a few seconds, the menu will switch back to the main menu automatically.

## Music/Speech tone adjustment

RDS radio stations differentiate between music and speech programs.

You can adjust the tone for speech programs:

- Off - no tone adjustment
- Level 1 - linear (no bass, treble and Loudness changes)
- Level 2 - 4 - different adjustments for volume, bass and treble with Loudness switched off

Choose the setting you prefer.

Traffic announcements are always played in the "Speech" mode.

- ⇨ Press **OK** to access the DSC menu.
- ⇨ Press **T/V** to select the menu item **Radio**.
- ⇨ Press **OK**.
- ⇨ Press **T/V** to select the menu item **Music/Speech**.

- ⇨ Press **OK**.
- ⇨ Press **</>** to select the desired setting.
- ⇨ Press **OK** to confirm your selection.
- ⇨ Press **SRC** to exit the DSC menu.

## Loudness

### Switching Loudness on/off

- ⇨ To switch Loudness on/off, press **AUDIO** for approx. 1 second until you hear a beep.

**LOUDNESS ON** or **LOUDNESS OFF** will appear briefly in the display.

### Adjusting Loudness increase

Loudness boosts low frequencies for more bass, especially at low volume, for a more natural sound.

You can adjust the Loudness setting as follows:

- LOUD 1 - minimum boost
- LOUD 6 - maximum boost

- ⇨ Press **OK** to access the DSC menu.
- ⇨ Press **T/V** to select the menu item **Radio**.
- ⇨ Press **OK**.
- ⇨ Press **T/V** to select the menu item **Loudness**.
- ⇨ Press **OK**.
- ⇨ Press **</>** to select the desired setting.
- ⇨ Press **OK** to confirm your selection.
- ⇨ Press **SRC** to exit the DSC menu.

## Adjusting brightness, colour and legibility

### Adjusting the colour of the Radiophone lighting

You can adjust the equipment lighting in stages to match it to the dashboard lighting in your vehicle.

The colours can be changed in different shades between green and red.

- ⇨ Press **OK** to access the DSC menu.
- ⇨ Press **↔** to select the menu item **Setup**.
- ⇨ Press **OK**.
- ⇨ Press **↔** to select the menu item **Vario Colour**.
- ⇨ Press **OK**.
- ⇨ Press **↔** to select the desired setting.
- ⇨ Press **OK** to confirm your selection.
- ⇨ Press **SRC** to exit the DSC menu.

### Adjusting the brightness of the Radiophone lighting

You can adjust the brightness of the lighting for day (D) and night lighting (N) in stages, depending on how the instrument lighting has been connected.

- ⇨ Press **OK** to access the DSC menu.
- ⇨ Press **↔** to select the menu item **Setup**.
- ⇨ Press **OK**.
- ⇨ Press **↔** to select the menu item **Brightness**.
- ⇨ Press **OK**.
- ⇨ Press **↔** to select **D** or **N**.
- ⇨ Press **OK**.
- ⇨ Press **↔** to select the desired setting.
- ⇨ Press **OK** to confirm your selection.
- ⇨ Press **SRC** to exit the DSC menu.

### Optimising display legibility (Angle)

You can adjust the legibility of the display to the best angle.

- ⇨ Press **OK** to access the DSC menu.
- ⇨ Press **↔** to select the menu item **Setup**.
- ⇨ Press **OK**.
- ⇨ Press **↔** to select the menu item **Angle**.
- ⇨ Press **OK**.
- ⇨ Press **↔** to select the desired setting.
- ⇨ Press **OK** to confirm your selection.
- ⇨ Press **SRC** to exit the DSC menu.

### Selecting the system language

You can select the language in which the text will appear in the display. If there is no SIM card in the Radiophone, the text will appear in English if you select the setting **Automatic Text**. If there is a SIM card in the Radiophone, the language used by the SIM card will appear.

- ⇨ Press **OK** to access the DSC menu.
- ⇨ Press **↔** to select the menu item **Setup**.
- ⇨ Press **OK**.
- ⇨ Press **↔** to select the menu item **Language**.
- ⇨ Press **OK**.
- ⇨ Press **↔** to select the desired setting.
- ⇨ Press **OK** to confirm your selection.
- ⇨ Press **SRC** to exit the DSC menu.

## BASIC FUNCTIONS

---

### Optical theft protection

You can select whether or not the card tongue should flash as optical theft protection.

- ⇨ Press **OK** to access the DSC menu.
- ⇨ Press **↵/▼** to select the menu item **Setup**.
- ⇨ Press **OK**.
- ⇨ Press **↵/▼** to select the menu item **Card LED**.
- ⇨ Press **OK**.
- ⇨ Press **↵/▼** to select **Off** or **On**.
- ⇨ Press **OK**.
- ⇨ Press **SRC** to exit the DSC menu.

### Changing the DSC access code

Before you can make any changes to important settings in the DSC menu, you will be required to enter a code. This code is set to 0000 at the factory. You can alter this code at any time.

- ⇨ Press **OK** to access the DSC menu.
- ⇨ Press **↵/▼** to select the menu item **Setup**.
- ⇨ Press **OK**.
- ⇨ Press **↵/▼** to select the menu item **Change code**.
- ⇨ Press **OK**.
- ⇨ Use the number keys to enter the factory code, or if the code has already been changed, the currently valid code.
- ⇨ Use the number keys to enter the new code.
- ⇨ Enter the new code a second time.
- ⇨ Press **SRC** to exit the DSC menu.

### Resetting personal settings

You can reset any of the settings made in the DSC menu for the radio, the phone or the SIM card.

- ⇨ Press **OK** to access the DSC menu.
- ⇨ Press **↵/▼** to select the menu item **Setup**.
- ⇨ Press **OK**.
- ⇨ Press **↵/▼** to select the menu item **Reset**.
- ⇨ Press **OK**.
- ⇨ Use the number keys to enter the DSC access code.
- ⇨ Press **↵/▼** to select the desired setting.
- ⇨ Press **OK** twice.
- ⇨ Press **SRC** to exit the DSC menu.

### Connecting auxiliary equipment

In place of a CD changer, you can also connect any other auxiliary audio source with a line output. These sources include a portable CD player, MiniDisc player or MP3 player.

To connect an external audio source, you need an adapter cable. You can purchase an adapter cable from any authorised Blaupunkt dealer.

### Switching the auxiliary equipment on/off

- ⇨ During radio operation, press **OK** to access the DSC menu.
- ⇨ Press **↵/▼** to select the menu item **Radio**.
- ⇨ Press **OK**.
- ⇨ Press **↵/▼** to select the menu item **Aux**.
- ⇨ Press **OK**.
- ⇨ Press **↵/▼** to select **Off** or **On**.
- ⇨ Press **OK**.
- ⇨ Press **SRC** to exit the DSC menu.

If the auxiliary audio source is connected properly and switched on in the DSC menu, it can be selected by pressing **SRC**.

## CODE theft protection

The Radiophone has been equipped with a code for effective protection against theft. The code must be entered each time the unit is disconnected from its power supply. The code inquiry can be switched on or off.

### Switching the code inquiry on/off

- ⇨ With the Radiophone switched off, press and hold down number keys **1** and **4**.
- ⇨ Switch the Radiophone on by inserting the SIM card or pressing the **ON** button.

A code inquiry will appear in the display.

- ⇨ Use the number keys to enter the valid code.

The code inquiry will be switched either on or off.

### Note:

You will find the valid code in the radio pass included with the Radiophone.

If the code is entered incorrectly three times, you will have to wait for a fixed time period. "WAIT 1 HOUR" appears in the display. The unit must remain switched on during this hour.

## Radio operation

This Radiophone has been equipped with an RDS radio receiver. Many FM stations now transmit a signal along with their regular programming to provide such additional information as the station name. The station name will appear in the display as soon as it is received.

Other RDS advantages include the AF and REG functions.

### Selecting the radio mode

If the Radiophone is currently in the telephone or CD changer mode,

- ⇨ press **SRC** repeatedly until the radio mode functions appear.

### Note:

The telephone mode has priority. If the phone is in use, you cannot switch to the radio or CD changer modes.

### RDS convenience functions (AF, REG)

The RDS convenience functions, AF (Alternate Frequency) and REG (REGional), enhance the performance of your car radio.

- AF: When this RDS function has been activated, the radio will automatically search for the best frequency in reception range of the station selected.
- REG: A number of radio stations broadcast special programs for different regions with different contents. If you activate the REG function, the radio will not automatically switch to an alternate frequency with different regional programming.

### Switching AF on/off

- ⇨ Press **#/AF** briefly.

"AF" will light up in the display when this RDS function has been activated.

# RADIO OPERATION

---

## Switching REG on/off

- ⇨ Press **#/AF** for approx. 1 second until **REGIONAL ON** or **REGIONAL OFF** appears in the display.

**REG** will appear in the display when this RDS function has been activated.

## Selecting the memory bank/waveband

With this radio, you can tune into stations on the FM and AM (MW and LW) wavebands.

- ⇨ Press **BND** to switch between the wavebands or memory banks.

## Selecting a radio station

There are different ways in which you can select a radio station.

### Automatic station selection (seek tuning)

- ⇨ Press **▲** or **▼**.

The radio will tune into the next station within reception range.

### Selecting seek tuning sensitivity

Use this function to determine whether the radio tunes into only those stations with strong reception signals or into weaker stations as well.

- ⇨ Press **\*** to switch between high sensitivity (stations with weaker signals) and low sensitivity (local stations).

lo will light up in the display if you have selected low sensitivity.

In the DSC menu you can also select the degree of sensitivity for LO (local) and DX (distant) reception.

- ⇨ Press **OK** to access the DSC menu.
- ⇨ Press **▲/▼** to select the menu item **Radio**.
- ⇨ Press **OK**.

- ⇨ Press **▲/▼** to select the menu item **Sensitivity**.
- ⇨ Press **OK**.
- ⇨ Press **▲/▼** to select the menu item **DX** or **LO**.
- ⇨ Press **OK**.
- ⇨ Press **</>** to select the desired setting.
- ⇨ Press **OK**.
- ⇨ Press **SRC** to exit the DSC menu.

## Searching for/selecting radio stations manually

You can also select a radio station manually.

- ⇨ Press **<** or **>**.

### Note:

You will not be able to select a station manually unless AF is deactivated.

## Entering a station frequency directly

For FM and FMT you can also enter a station frequency directly with the number buttons.

- ⇨ Press **0**.
- ⇨ Enter the frequency without adding the decimal point.
- ⇨ If you want to delete your entry, press **CLR**.

## Paging through station networks

If one radio station has several different programs, you can page through this “station network”.

- ⇨ Press **<** or **>** to tune into the next station in the station network.

### Note:

To use this function, you must have activated the RDS convenience functions first.

## Storing stations manually

- ⇨ Select the desired memory bank: FM, FMT, MW or LW.
- ⇨ Select the desired station.



For the station presets 1 - 9

- ⇨ press one of the buttons **1 - 9** for approx. 1 second until you hear a beep.

For the station presets 10 - 19 (for FM only)

- ⇨ press **1** briefly and
- ⇨ then press one of the button **0 - 9** for approx. 1 second until you hear a beep.

## Storing the stations with the strongest signals automatically (Travelstore)

You can automatically store the nine stations with the strongest reception signals in the region (FM only). These stations will be stored in the FMT memory bank.

### Note:

Any stations already stored in this memory bank will be deleted automatically.

- ⇨ Press **BND/TS**.

The storing process will begin. **TRAVELSTORE** will flash in the display.

Once the storing process has been completed, the radio station stored on preset 1 in the FMT memory bank will begin to play. The station list will appear in the display for several seconds.

## Recalling stored stations

There are different ways in which you can recall stored radio stations.

### Numbers buttons

- ⇨ Select the memory bank or the waveband.

For station presets 1 - 9

- ⇨ press the desired button from **1 - 9** briefly.

For station presets 10 - 19

- ⇨ first press the **1** briefly
- ⇨ then press the desired button from **0 - 9** within 2 seconds.

## Menu

- ⇨ Press **BND** to select the memory bank or waveband.
- ⇨ Press **MEM**.

A menu listing the stations stored will appear in the display.

- ⇨ Press **▲/▼** to select the desired station.
- ⇨ Press **OK** to tune into the station selected.

## Switching between stereo and mono

When you switch the Radiophone on, it will automatically begin to play in stereo. If station reception should begin to deteriorate, the Radiophone will automatically switch to mono.

## Selecting Radiotext display

- ⇨ Press **OK** to access the DSC menu.
- ⇨ Press **▲/▼** to select the menu item **Radio**.
- ⇨ Press **OK**.
- ⇨ Press **▲/▼** to select the menu item **Radiotext**.
- ⇨ Press **OK**.
- ⇨ Press **▲/▼** to select one of the following settings:
  - Off - switched off
  - On - switched on
  - On/Eng. off - switched on only when the engine is off
- ⇨ Press **OK** to confirm your selection.
- ⇨ Press **SRC** to exit the DSC menu.

## Traffic radio reception

### Switching priority for traffic announcements on/off

⇨ Press **TA**.

When traffic announcement priority is switched on, TA will light up in the display.

#### Note:

You will hear a warning beep,

- if you leave the reception range of the traffic radio station you are listening to
- if you leave the reception range of the traffic radio station you are tuned into while listening to a CD and the automatic seek tuning function is unable to find another traffic radio station
- if you switch from a traffic radio station to a radio station that does not broadcast traffic information

In this case, either switch off traffic announcement priority or switch to a radio station that broadcasts traffic information.

## CD changer operation

### Selecting the CD changer mode

If the Radiophone is currently in the telephone or radio mode,

⇨ press **SRC** repeatedly until the CD changer functions appear in the display.

#### Note:

The telephone mode has priority. If the phone is in use, you cannot switch to the radio or CD changer modes.

### Selecting a CD

There are different ways in which you can select a CD.

#### Selecting the next CD up or down

⇨ To select the next CD up or down, press **▲** or **▼** once or as often as necessary.

#### Selecting the CD directly using the numbers buttons

⇨ Press the corresponding numbers button from **1 - 9**.

#### Selecting a CD directly from the menu

⇨ Press **MEM**.

A menu listing the CDs available will appear in the display.

⇨ Press **▲/▼** to select the desired CD.

⇨ Press **OK** to begin CD playback.

### Selecting a track on a CD

⇨ To select a track up or down on the CD currently playing, press **<** or **>** once or repeatedly as required.

### Fast Cue/Review (audible)

For fast Cue or Review

⇨ press and hold down **<** or **>** until Cue or Review begins.

## Playing tracks in random order (MIX)

- ⇨ Press **\*MIX** briefly.

All of the tracks on the CD currently playing will be played in random order. When all the tracks on a CD have been played, the next CD will be selected and its tracks will play in random order.

- ⇨ To end the MIX function, press **\*MIX** again briefly.

## Displaying the list of CDs in the changer

- ⇨ Press **MEM**.

## Naming CDs

To allow you to recognise your CDs more quickly, you can enter individual names for up to 99 CDs. The names can contain up to seven characters.

- ⇨ In the CD changer mode, press **OK** to access the DSC menu.
- ⇨ Press **▲/▼** to select the menu item **Radio**.
- ⇨ Press **OK**.
- ⇨ Press **▲/▼** to select the menu item **Disc Naming**.
- ⇨ Press **OK**.
- ⇨ Press **▲/▼** to select the menu item **Change name**.
- ⇨ Press **OK**.
- ⇨ Press **▲/▼** to select the desired CD.
- ⇨ Press **OK**.

The first input field will flash. You can begin to enter the characters.

- ⇨ Use the numbers buttons to enter a name. For more information, read the section on "Entering names" in the chapter on the "Telephone".
- ⇨ Press **OK** to confirm your entry.

To continue to name other CDs, proceed as follows.

- ⇨ Press **▲/▼** to select the next CD you want to name.
- ⇨ Press **OK**.
- ⇨ Use the numbers buttons to enter the name.
- ⇨ Press **OK** to confirm your entry.

To stop naming CDs,

- ⇨ press **SRC**.

To exit Disc Naming without saving the entries made,

- ⇨ press **CLR** twice for a longer time.

## Deleting one or all the characters

While entering a name you can delete one or all the characters.

To delete one character,

- ⇨ press **</>** to select the character you want to delete.
- ⇨ Press **CLR** briefly.

To delete all of the characters,

- ⇨ press **CLR** for longer than 1 second.

# CD CHANGER OPERATION

---

## Deleting CD names

- ⇨ Press **OK** to access the DSC menu.
- ⇨ Press **⏪/⏩** to select the menu item **Radio**.
- ⇨ Press **OK**.
- ⇨ Press **⏪/⏩** to select the menu item **Disc Naming**.
- ⇨ Press **OK**.
- ⇨ Press **⏪/⏩** to select the menu item **Clear name**.
- ⇨ Press **OK**.

A selection menu with the names stored will appear.

To clear the name of one CD,

- ⇨ press **⏪/⏩** to select the desired name.
- ⇨ Press **OK**.

The name will be deleted. Then the selection menu with the names will appear again.

To clear all of the names stored,

- ⇨ press **OK** for longer than 1 second.

To exit the DSC menu,

- ⇨ press **SRC**.

## General information

### Emergency call

Using the Antares T 60 telephone, you can make emergency calls at any time anywhere in the world. Emergency calls can also be made **without** a valid **SIM card**. All you need is a GSM 900 network.

The emergency number in the GSM network is **112** all over the world. Your call is always put through to the nearest rescue control centre.

- ⇨ Switch the Radiophone on by pushing in the card tongue in.

If the Radiophone was switched off by pressing the on/off button,

- ⇨ press the on/off button.

The Radiophone will switch on.

- ⇨ Press .

The telephone mode will be activated, but please note: **No valid SIM card** will appear in the display.

- ⇨ Enter 112 on the 12-button keypad.

- ⇨ Press .

The call will be put through to the nearest rescue control centre.

Provide them with all of the necessary information as accurately as possible.

Do not end the call until you are told to do so!

### Important:

Use the **112** number in emergency situations only. Any improper use of the emergency call number could have legal consequences.

## Starting telephone operation

### Selecting the telephone mode

If you have already inserted a valid **SIM card**,

- ⇨ press .

The telephone mode will be activated. The network selected will appear in the display.

### Inserting the SIM card

With the card tongue pushed in,

- ⇨ press the card tongue gently in the direction of the Radiophone until you feel slight resistance.

- ⇨ Release the card tongue.

The card tongue will now eject from the Radiophone.

- ⇨ Lay the SIM card on the card tongue with the **chip facing upwards and towards the Radiophone** and push it into the slot until you feel slight resistance.

- ⇨ Press the **SIM card** gently down at the back onto the card tongue so that it is lying completely on the card tongue.

- ⇨ Push the card tongue into the Radiophone gently until you feel slight resistance and you **hear** the card tongue click into position.

The Radiophone will switch on. If the PIN inquiry has been activated, **ENTER PIN** will appear in the display. Also refer to "Switching the PIN code on/off".

### Entering the PIN code

The PIN code (personal identification number) protects your telephone against being used by unauthorised persons. The PIN code and the PUK (Personal Unblock code) are supplied along with the **SIM card** by your service provider. You can change the PIN code at any time; for more information, read "Changing the PIN code".

# STARTING TELEPHONE OPERATION

## Important:

Be sure to memorise your PIN code and do not reveal it to any unauthorised persons.

When **ENTER PIN** appears in the display,

- ⇨ enter your PIN number on the **0 - 9** keypad, beginning with the first digit.
- ⇨ After you have entered the PIN code completely, press **OK** or **#**.

## Note:

If you enter the PIN code incorrectly three times in succession, the **SIM card** will be locked. For more information, refer to the section on "Unlocking the SIM card".

Once the PIN code has been entered correctly and confirmed, the Radiophone will switch on and the operating mode used last (radio, CD changer or telephone) will be activated.

## Switching the PIN code on/off

If your SIM card supports this function, it is possible to switch the PIN inquiry on or off. If the PIN inquiry is switched off, anyone can use your SIM card and the Antares T 60 telephone. If the PIN inquiry is active, the valid PIN must be entered each time you switch the Radiophone on.

## Note:

It is not possible to switch off the PIN inquiry unless your SIM card supports this function.

- ⇨ Press  to switch to the telephone mode.
- ⇨ Press **OK**.

The DSC menu will appear in the display. The cursor **▶** will mark **Setup**.

- ⇨ Press **OK**.
- ⇨ Press **▼** as often as necessary until the cursor **▶** marks the menu item **PIN-code**.
- ⇨ Press **OK**.

- ⇨ Press **▼/▲** to select the PIN code you want to switch on or off (normally PIN 1).

- ⇨ Press **OK**.

A menu **PIN 1** containing all the functions available will appear in the display.

- ⇨ Press **▼/▲** to select the desired function **On** or **Off**.

- ⇨ Press **OK**.

The PIN code must be entered to confirm this change.

- ⇨ Enter your PIN on the **0 - 9** keypad, beginning with the first digit.

- ⇨ Press **OK**.

Now the Radiophone will return to the original **PIN 1** menu.

- ⇨ Press **CLR** repeatedly until you return to the main menu or press and hold down **CLR** for longer than one second to return to the DSC menu.

## Changing the PIN code

- ⇨ Access the **PIN 1** menu as described in the section on "Switching the PIN code on/off".

- ⇨ Press **▼/▲** to select the function **Change**.

- ⇨ Press **OK**.

- ⇨ Enter your **old** PIN on the **0 - 9** keypad, beginning with the first digit.

- ⇨ Press **OK**.

- ⇨ Enter your **new** PIN on the **0 - 9** keypad, beginning with the first digit

- ⇨ and confirm the **new** number by entering it again.

- ⇨ Press **OK**.

You will return to the **PIN 1** menu.

- ⇨ Press **CLR** repeatedly until you return to the main menu or press and hold down **CLR** for longer than one second to return to the DSC menu.

## Unblocking the SIM card

If you enter an incorrect PIN three times in succession, the SIM card will be locked. To unblock the SIM card, you have to enter the PUK. PUK stands for **P**ersonal **U**nblock**K** code. The PUK is an eight-digit number, supplied by your service provider along with your SIM card and the PIN code. The PUK cannot be changed!

If you insert a blocked SIM card into the Radiophone, **ENTER PUK** will appear in the display.

- ⇒ Enter your eight-digit **PUK** on the **0 - 9** keypad, beginning with the first digit and
- ⇒ press **OK** or **#**.

## Basic functions

### Adjusting the volume

You can adjust the volume for the ringing tone, hands-free function and for the handset (the handset is available as a special accessory) during a telephone call.

- ⇒ During a telephone call (while the phone is ringing or while you are speaking), turn the volume control knob to the left to decrease the volume and to the right to increase the volume.

It is also possible to adjust the volumes for the ringing tone, hands-free function and for the handset in a menu.

### Adjusting the ringing tone volume

The ringing tone volume can be adjusted in the menu in stages from 0 to 9.

#### Note:

By selecting 0 you will switch the ringing tone off. Incoming calls will then be indicated visually in the display only.

- ⇒ In the telephone mode, press **OK**.

The DSC menu will appear in the display. The cursor ► will mark **Setup**.

- ⇒ Press **OK**.

The Setup menu will appear in the display. The cursor ► will mark **Volume**.

- ⇒ Press **OK**.

- ⇒ Press **V** to select **Ringing tone**.

- ⇒ Press **OK**.

You will hear the phone ring at the volume currently selected.

- ⇒ Press **</>** or turn the volume control knob to select the desired volume.

- ⇒ Press **OK**.

You will return to the Volume menu.

# TELEPHONE SETTINGS

- ⇨ Press **CLR** repeatedly until you return to the main menu or press and hold down **CLR** for longer than one second to return to the DSC menu.

## Adjusting the hands-free volume

The hands-free volume can be adjusted in stages from 0 to 63.

- ⇨ In the telephone mode, press **OK**.

The DSC menu will appear in the display. The cursor ► will mark **Setup**.

- ⇨ Press **OK**.

The Setup menu will appear in the display. The cursor ► will mark **Volume**.

- ⇨ Press **OK**.

- ⇨ Press **V** to select **Handsfree**.

- ⇨ Press **OK**.

You will hear the phone ring at the volume currently selected.

- ⇨ Press **</>** or turn the volume control knob to select the desired volume.

- ⇨ Press **OK**.

You will return to the Volume menu.

- ⇨ Press **CLR** repeatedly until you return to the main menu or press and hold down **CLR** for longer than one second to return to the DSC menu.

## Adjusting the handset volume (handset optional)

The handset volume can be adjusted in stages from 1 to 8. This menu item will not be available unless the optional handset has been connected.

- ⇨ In the telephone mode, press **OK**.

The DSC menu will appear in the display. The cursor ► will mark **Setup**.

- ⇨ Press **OK**.

The Setup menu will appear in the display. The cursor ► will mark **Volume**.

- ⇨ Press **OK**.

- ⇨ Press **V** to select **Handset**.

- ⇨ Press **OK**.

On the handset, you will hear the phone ring at the volume currently selected.

- ⇨ Press **</>** or turn the volume control knob to select the desired volume.

- ⇨ Press **OK**.

You will return to the Volume menu.

- ⇨ Press **CLR** repeatedly until you return to the main menu or press and hold down **CLR** for longer than one second to return to the DSC menu.

## Traffic announcements (TA) during hands-free operation

You can select whether you want traffic messages to be put through or held back while you are using the phone.

- ⇨ In the telephone mode, press **OK**.

The DSC menu will appear in the display. The cursor ► will mark **Setup**.

- ⇨ Press **OK**.

- ⇨ Press **V** to select **TA / Call**.

- ⇨ Press **OK**.

The **TA DURING CALL** menu will appear in the display.

- ⇨ Press **V** to select the desired option **On** or **Off**.

- ⇨ Press **OK**.

If you have selected **On**, you must also select the channel over which the traffic information will be emitted.

- ⇨ Press **V** to make the desired setting **Left** or **Right**.

- ⇨ Press **OK**.

You will return to the Setup menu.

- ⇨ Press **CLR** repeatedly until you return to the main menu or press and hold down **CLR** for longer than one second to return to the DSC menu.



## Selecting the ringing tone

You can select from among six different ringing tones:

- Up and down,
- Oktave,
- Trill,
- 2x Oktave,
- 2x Trill,
- Triad and
- Off.

⇨ In the telephone mode, press **OK**.

The DSC menu will appear in the display. The cursor ► will mark **Setup**.

⇨ Press **OK**.

⇨ Press **Y** to select **Ring. tones**.

⇨ Press **OK**.

The **RING. TONES** menu will appear in the display.

⇨ Press **Y** to select **Ring. tone**.

⇨ Press **OK**.

The ringing tone currently selected will be played repeatedly.

⇨ Press **Y/▲** to select the desired ringing tone.

⇨ Press **OK**.

You will return to the **RING. TONES** menu.

⇨ Press **CLR** repeatedly until you return to the main menu or press and hold down **CLR** for longer than one second to return to the DSC menu.

## Service functions

### Audible call timer

With the audible call timer you can have a signal sound at selected intervals during a phone call. This function allows you to keep track of the telephone costs.

The time interval for the audible call timer function can be set from 15 to 300 seconds.

⇨ In the telephone mode, press **OK**.

The DSC menu will appear in the display. The cursor ► will mark **Setup**.

⇨ Press **OK**.

⇨ Press **Y** to select **Audib. timer**.

⇨ Press **OK**.

The **AUDIBLE CALL TIMER** menu will appear. The number of seconds selected is indicated after **TIMER**.

⇨ Press **Y** to select the desired setting **Off** or **TIMER**.

⇨ Press **OK**.

If you select **Off**, you will return to the Setup menu.

If you select **TIMER**, you can set the time interval for the signal sound.

### Setting the timer

⇨ Use the **0 - 9** keypad to enter the desired interval. Use **CLR** to correct your entry if necessary.

⇨ Press **OK**.

You will return to the Setup menu.

⇨ Press **CLR** repeatedly until you return to the main menu or press and hold down **CLR** for longer than one second to return to the DSC menu.

# TELEPHONE SETTINGS

---

## Displaying call charges/time

If this function is supported by your service provider, you can display the call time and the charges for the last call and for all calls.

⇨ In the telephone mode, press **OK**.

The DSC menu will appear in the display. The cursor ► will mark **Setup**.

⇨ Press **Y** to select **Menu**.

⇨ Press **OK**.

⇨ Press **Y** to select **Call meters**.

⇨ Press **OK**.

The **CALL METERS** menu will appear in the display.

⇨ Press **Y** to select the option for displaying the last calls or all calls.

⇨ Press **OK**.

The desired information will appear in the display.

⇨ If you want to return to the previous menu, press **OK**.

## Resetting the counter

⇨ In the **CALL METERS** menu, select the menu item **Reset**.

⇨ Use the **0 - 9** keypad to enter the Radiophone access code.

You will return to the **CALL METERS** menu.

⇨ Press **CLR** repeatedly until you return to the main menu or press and hold down **CLR** for longer than one second to return to the DSC menu.

## Setting the Charges, Time display during a call

During a call, you can have either the current charges or the elapsed call time displayed.

⇨ In the **CALL METERS** menu, select the menu item **During call**.

The **SHOW DURING CALL** menu will appear in the display.

⇨ Press **OK**.

⇨ Press **Y** to select the desired setting for **Charge** or **Time**.

⇨ Press **OK**.

You will return to the **CALL METERS** menu.

⇨ Press **OK**.

⇨ Press **CLR** repeatedly until you return to the main menu or press and hold down **CLR** for longer than one second to return to the DSC menu.

## Using the telephone

### Dialing phone numbers

You can dial phone numbers in four different ways:

- Manual dialing
- One-touch dialing
- Speed-dial and
- Selecting numbers from the phone book.

#### Manual dialing

- ◇ Use the **0 - 9** number keys to enter the number you want to dial, including the area code.
- ◇ If you enter an incorrect digit by mistake, you can press CLR, < and > to correct your mistake.
- ◇ Once you can see the complete number in the display, press .

The Radiophone will now dial the number.

#### Note:

When you dial numbers in the GSM network, you are always required to dial the area code first. Even if you dial the mobile phone number of a subscriber in the same network, you must still dial the area code first. The only numbers which do not require an area code are the service numbers supplied to you by your provider.

#### One-touch dialing (from the Radiophone memory)

You can dial the phone numbers stored for keys 1 to 9 on your Radiophone at the touch of a button.

- ◇ Press down the corresponding key from **1 - 9** to dial the number stored in the Radiophone memory.

The corresponding number or the name entered for the number will appear in the display and the dialing process will begin.

#### Speed-dial (from the SIM card memory)

You can dial the phone numbers stored for keys 1 to 9 on your SIM card at the touch of a button.

- ◇ Press **\***.
- ◇ Press down the corresponding key from **1 - 9** to dial the number stored in the SIM card memory.

The corresponding number or the name entered for the number will appear in the display and the dialing process will begin.

#### Selecting a number from the phone book

Telephone numbers that you have already stored in the phone book can also be selected directly. For more information on storing numbers and names in the phone book, please refer to the chapter entitled "Phone book".

- ◇ While the Radiophone is in the telephone mode, press **MEM**.

The phone book will appear. You can choose as to whether you want to find the entry by its name or its position in the memory.

- ◇ Press **V** to select the search method you want to use.
- ◇ Press **OK**.

#### Finding an entry by name

If you select the option **Find entry by name**, you will be required to enter the first few letters of the name.

- ◇ Use the **0 - 9** keys to enter up to the first three letters of the entry. For more information, read the section on "Entering names and telephone numbers" in the chapter entitled "Phone book".
- ◇ Press **OK**.

The corresponding section of the phone book will appear in the display. If there is no entry matching the letters entered, the section with the next closest letter will appear.

- ◇ Use **V/T** to select the desired entry.
- ◇ Press .

The Radiophone will now dial this number.

## USING THE TELEPHONE

### Selecting the phone number from the list of last numbers dialed

The last numbers you dialed will automatically be stored on the SIM card. You can use this list to place calls to these numbers.

- ◇ While the Radiophone is in telephone mode, press  briefly.

The list with the numbers dialed last will appear.

- ◇ Use **V/Λ** to select the desired number.
- ◇ Press .

The Radiophone will now dial this number.

### Selecting the phone number from the list of missed calls

Any calls you may have missed will be stored in a list. You can use this list to place calls to these numbers. These numbers will not be stored unless the caller has activated call line identification.

- ◇ While the Radiophone is in telephone mode, press **V** briefly.

The list indicating the numbers of the calls that have been missed will appear in the display. If the caller's number has been stored along with the name in the phone book, the corresponding name will appear in the display.

- ◇ Use **V/Λ** to select the desired entry.
- ◇ Press .

The Radiophone will now dial this number.

### Selecting the phone number from the list of calls received

The calls you receive are also stored on a list. You can use this list to place calls to these numbers. These numbers will not be stored unless the caller has activated call line identification.

- ◇ While the Radiophone is in telephone mode, press **Λ** briefly.

The list indicating the numbers of the calls that have been received will appear in the display. If the caller's number has been stored along with the name in the phone book, the corresponding name will appear in the display.

- ◇ Use **V/Λ** to select the desired entry.
- ◇ Press .

The Radiophone will now dial this number.

### Deleting an entry from the incoming/outgoing call list

- ◇ Select the desired list (incoming/outgoing calls).
- ◇ Use **V/Λ** to select the desired entry.
- ◇ Press **<** or **>**.
- ◇ Confirm the following query with **OK**.

### Deleting the incoming/outgoing call list

- ◇ Select the desired list (incoming/outgoing calls).
- ◇ Use **V/Λ** to select the corresponding list (**Redial list**, **Rec'd calls**, **Calls**).
- ◇ Press **<** or **>**.
- ◇ Confirm the following query with **OK**.

### Answering a call

Incoming calls are indicated by the ringing tone, the message **Accept?** in the display and the display will change colour.

If you want to accept the call,

- ◇ press  or
- ◇ pick up the handset receiver (if connected).

### Note:

It is possible to switch off the ringing tone. For more information, refer to the section on "Setting the ringing tone volume" in the chapter on "Basic functions".

## Automatic answer

In the Setup menu, you can make a setting so that all incoming calls are answered automatically.

⇨ In the telephone mode, press **OK**.

The DSC menu will appear. The cursor ► will mark **Setup**.

⇨ Press **OK**.

⇨ Press **Y** to select **Auto. answer**.

⇨ Press **OK**.

The **AUTOMATIC ANSWER** menu will appear in the display.

⇨ Press **Y** to select the desired setting **On** or **Off**.

⇨ Press **OK**.

You will return to the Setup menu.

## Rejecting a call

If you do not want to answer a call,

⇨ press **CLR** while the phone is ringing.

The caller will hear a busy signal.

## Switching the microphone to mute

During a call, you can switch the microphone to mute.

⇨ Press **AUDIO**.

**Mute On** will appear in the display.

## Switching off the mute function

⇨ Press **AUDIO** again.

**Mute Off** will appear briefly in the display.

## Redial

You can have a number redialled from the list of the numbers called last. For more information, refer to the section on "Dialling telephone numbers from the list of the last calls made" in this chapter.

## Automatic redial

In the Setup menu, you can make a setting so that the number is redialled automatically until the call goes through.

⇨ In the telephone mode, press **OK**.

The DSC menu will appear. The cursor ► will mark **Setup**.

⇨ Press **OK**.

⇨ Press **Y** to select **Auto. redial**.

⇨ Press **OK**.

The **AUTOMATIC REDIAL** menu will appear in the display.

⇨ Press **Y** to select the desired setting **On** or **Off**.

⇨ Press **OK**.

You will return to the Setup menu.

## Ending the automatic redial function

⇨ Once the dialling process has begun, press  to end automatic redial.

## Call waiting (2nd call on hold)

During a telephone call, you can also accept a second incoming call. The first caller will then be put on "hold".

### Note:

It might be necessary to order "Call waiting" service from your provider. Your service provider has more detailed information.

## Answering the 2nd call

If you receive a second call while you are already using the telephone, you will hear a signal; if you want to answer the 2nd call,

⇨ press **OK**.

The first caller will be put on "hold".

## Rejecting the 2nd call

⇨ Press **CLR**.

The caller will hear a busy signal.

# USING THE TELEPHONE

---

## Hold/broker's calls

Hold means that you place or receive a second call, while you are already using the telephone. You can only speak to one caller at a time. The callers have no contact with one another.

### Hold

When you are already using the phone,

- press **MEM** to activate the hold function.
- Now you can use the **0 - 9** buttons to enter the telephone number for the second call.
- Once the complete number appears in the display, press .

The call will be put through to the second number. The first caller will stay on "hold".

### Broker's calls

A broker's call means you switch from one caller to the other.

- Press **MEM** to switch between the two callers.

### Note:

With a caller on "hold", you can also accept a third incoming call. Press **OK** to accept the call or **CLR** to reject it.

If you accept a third call, the connection to the active caller will be terminated.

## Conference calls

With conference calls there is a direct connection between all of the callers.

Once you have two callers as described in the section on "Hold/broker's calls",

- press **OK**.

The conference call will be set up. **CONFERENCE** will appear in the display.

### Ending a conference call

To end the conference call,

- press **CLR**.

### Note:

During a conference call you can also answer a call from a third caller. Press **OK** to answer the call or **CLR** to reject it. The conference will be put on "hold". Then you can press **MEM** to switch between the conference call and the third caller (broker's call).

## Notebook function

During a telephone call you can use the keypad to enter a telephone number. After the call has ended, the number will appear in the display and can be used as desired.

### Note:

If the vehicle ignition is switched off during a telephone call, the Radiophone will switch off automatically after the call has ended. Any telephone number you have entered in the notebook will be deleted.

## Foreign calls

The internationally uniform GSM standard allows you to place telephone calls with your **RADIOPHONE** in foreign countries as well.

It is necessary that there is a roaming agreement between the service providers in the two countries. In addition, your service provider must activate international roaming for your **SIM** card.

You can obtain a current list of the countries with the service providers responsible (network code and name) and the different charges involved.

### Note:

If you want to place calls using your **RADIOPHONE** in a foreign country, contact your service provider well in advance.

## What do you have to do before travelling to a foreign country?

- ◇ If you have not already done so, have your service provider activate your SIM card for international roaming.

## How do I place a telephone call to a foreign country?

- ◇ Dial the corresponding country code,
- ◇ enter the area code and then
- ◇ the telephone number.

### Note:

You can replace the first two digits of the country code with + (press **0** for approx. one second).

### Example:

Country code:	0049	Germany
Area code:	05121	Hildesheim
Phone number:	49 . . . .	Blaupunkt

The number you enter: +49512149 . . . .

### Note:

Enter the country code for all the telephone numbers you want to store.

## How can I be reached?

Callers from your home country simply dial your Radiophone number. Callers outside of your home country must first dial your usual country code, even if you are currently in a foreign country.

## How do I call a wired network telephone number in the foreign country?

- ◇ Dial the area code and
- ◇ then the telephone number.

The country code is not entered because your Radiophone has logged onto the foreign network.

## Selecting a network

In areas served by more than one GSM network, you can select a preferred network. It is necessary for your provider to have a roaming agreement with that network. In addition, you can also list the networks according to priority. This can prove useful for your trips abroad because sometimes the difference in the charges made by the different networks is considerable. For more information, read the section on "Foreign calls".

### Displaying the available networks

- ◇ In the telephone mode, press **OK**.
- ◇ Press **▼** to select **Menu**.
- ◇ Press **OK**.
- ◇ Press **▼** to select **Network sel.**
- ◇ Press **OK**.

The **NETWORK SELECTION** menu will appear in the display.

- ◇ Press **▼** to select **Available**.
- ◇ Press **OK**.

After a short search, a list of the available GSM networks will appear.

### Adjusting the network search method

You can select whether a manual or an automatic search is made for the GSM networks.

- ◇ In the telephone mode, press **OK**.
- ◇ Press **▼** to select **Menu**.
- ◇ Press **OK**.
- ◇ Press **▼** to select **Network sel.**
- ◇ Press **OK**.

The **NETWORK SELECTION** menu will appear in the display.

- ◇ Press **▼** to select **Search method**.
- ◇ Press **OK**.
- ◇ Press **▼/▲** to select the desired method.
- ◇ Press **OK**.

## USING THE TELEPHONE

---

You will return to the **NETWORK SELECTION** menu.

- ⇨ Press **CLR** as often as necessary until you return to the main menu or press and hold **CLR** for longer than one second to return to the DSC menu.

### Editing the network list

You can edit the network list to select preferred GSM networks.

#### Adding a GSM network to the list

- ⇨ In the telephone mode, press **OK**.
- ⇨ Press **Y** to select **Menu**.
- ⇨ Press **OK**.
- ⇨ Press **Y** to select **Network sel.**
- ⇨ Press **OK**.

The **NETWORK SELECTION** menu will appear in the display.

- ⇨ Press **Y** to select **Prof. list**.
- ⇨ Press **OK**.
- ⇨ Press **Y** to select **Add**.
- ⇨ Press **OK**.

Now you can either enter a new GSM network or add one which has already been stored in the Radiophone to the list.

- ⇨ Press **Y** to select **Known** or **New**.

#### Note:

If you want to add a new GSM network to the list, you will be required to enter the network code and the network name. Your provider can supply you with this information.

If you select **Known**, a list of the factory-programmed GSM networks will appear.

- ⇨ Press **Y/Λ** to select the desired network.
- ⇨ Press **OK**.

You will return to the **PREF. LIST** menu.

### Moving an entry on the list

- ⇨ Select the menu item **Move** in the **PREF. LIST** menu.

- ⇨ Press **OK**.

The current network list will appear in the display.

- ⇨ Press **Y** to select the entry you want to move.

- ⇨ Press **OK**.

- ⇨ Press **Y/Λ** to move the GSM network to its new position.

- ⇨ Press **OK**.

You will return to the **PREF. LIST** menu.

### Deleting an entry on the list

- ⇨ Select the menu item **Delete** in the **PREF. LIST** menu.

- ⇨ Press **OK**.

The current network list will appear in the display.

- ⇨ Press **Y** to select the entry you want to delete.

- ⇨ Press **OK**.

The GSM network selected will be deleted from the list. You will return to the **PREF. LIST** menu.

### Call forwarding

You can set call forwarding for different situations.

- General call forwarding
- Call forwarding if busy
- Call forwarding if no answer
- Call forwarding if unreachable (outside of your provider's service area)



## Registering call forwarding

- ⇨ In the telephone mode, press **OK**.
- ⇨ Press **Y** to select **Menu**.
- ⇨ Press **OK**.
- ⇨ Press **Y** to select **Forwarding**.
- ⇨ Press **OK**.

The **FORWARDING** menu will appear in the display.

- ⇨ Press **Y** to select the situation for which you want to activate call forwarding.
- ⇨ Press **OK**.
- ⇨ Press **Y** to select whether you want to activate call forwarding for any or all of the following services: telephone calls, data transmission, faxes.
- ⇨ Press **OK**.
- ⇨ Select **Register**.
- ⇨ Press **OK**.
- ⇨ Enter the complete telephone number to which you want to forward the calls on the **0 - 9** buttons.
- ⇨ Press **OK**.

## Activating call forwarding

- ⇨ Proceed as described for “Registering call forwarding”
- ⇨ For your last selection, select **Activate**.
- ⇨ Press **OK**.

You will return to the **FORWARDING** menu.

## Deactivating call forwarding

- ⇨ Proceed as described for “Registering call forwarding”
- ⇨ For your last selection, select **Deactivate**.
- ⇨ Press **OK**.

## Displaying call forwarding status

- ⇨ Proceed as described for “Registering call forwarding”
  - ⇨ For your last selection, select **Status**.
- The status of the call forwarding function will be indicated in the display.
- ⇨ Press **OK**.

## Deleting individual call forwarding functions

- ⇨ Proceed as described for “Registering call forwarding”
- ⇨ For your last selection, select **Delete**.
- ⇨ Press **OK**.

The call forwarding function selected will be deleted.

## Deleting all the call forwarding functions

- ⇨ Select the menu item **Delete** in the **FORWARDING** menu.
- ⇨ Press **OK**.

An inquiry will appear in the display. You must confirm it if you really want to delete.

- ⇨ Select **Yes** if you really want to delete all the call forwarding functions.
- ⇨ Press **OK**.

## Call barring

You can bar incoming or outgoing calls. In order to do so, you require a password, which you can obtain from your provider.

### Activating call barring

- ⇨ In the telephone mode, press **OK**.
- ⇨ Press **Y** to select **Menu**.
- ⇨ Press **OK**.
- ⇨ Press **Y** to select **Barring**.
- ⇨ Press **OK**.

The **BARRING** menu will appear in the display.

# USING THE TELEPHONE

- ⇨ Press **Y** to select call barring for incoming or outgoing calls.
- ⇨ Press **OK**.
- ⇨ Press **Y** to select whether you want to activate call forwarding for any or all of the following services: telephone calls, data transmission, faxes.
- ⇨ Press **OK**.
- ⇨ Press **Y** to select **Activate**.
- ⇨ Press **OK**.
- ⇨ Enter the password with buttons **0 - 9**.
- ⇨ Press **OK**.

You will return to the **BARRING** menu.

## Deactivating call barring

- ⇨ Proceed as described under "Activating call barring".
- ⇨ For your last selection, select **Deactivate**.
- ⇨ Enter the password with buttons **0 - 9**.
- ⇨ Press **OK**.

## Displaying call barring status

- ⇨ Proceed as described under "Activating call barring".
- ⇨ For your last selection, select **Status**.
- ⇨ Press **OK**.

The call barring status will appear in the display.

## Changing the password for call barring

- ⇨ Select the menu item **Password** in the **BARRING** menu.
- ⇨ Press **OK**.
- ⇨ Enter the **old** password with the buttons **0 - 9**.
- ⇨ Press **OK**.
- ⇨ Enter the **new** password with the buttons **0 - 9** twice.
- ⇨ Press **OK**.

## Locking the Phone

There are different ways in which you can lock your Radiophone.

- No calls possible except for emergency calls (**All**)
- Only the numbers stored from 1-9 on the SIM card (**One-touch**)
- SIM card numbers and Radiophone numbers (**One-touch and speed-dial**).

## Switching on the phone lock

- ⇨ In the telephone mode, press **OK**.
- ⇨ Press **Y** to select **Menu**.
- ⇨ Press **OK**.
- ⇨ Press **Y** to select **Phone lock**.
- ⇨ Press **OK**.

The **PHONE LOCK** menu will appear in the display.

- ⇨ Press **Y** to select one of the phone lock options as described above.
- ⇨ Press **OK**.
- ⇨ Enter the access code using the buttons **0 - 9**.

You will return to the **PHONE LOCK** menu.

## Switching off the phone lock

- ⇨ In the telephone mode, press **OK**.
- ⇨ Press **Y** to select **Menu**.
- ⇨ Press **OK**.
- ⇨ Press **Y** to select **Phone lock**.
- ⇨ Press **OK**.

The **PHONE LOCK** menu will appear in the display.

- ⇨ Press **Y** to select **Off**.
- ⇨ Press **OK**.
- ⇨ Enter the access code using the buttons **0 - 9**.

You will return to the **PHONE LOCK** menu.

## Phone book

### Entering names and telephone numbers

Names and telephone numbers are entered using the buttons **0 - 9**.

The buttons are sequence buttons, so that you are required to sometimes press the button repeatedly to get the desired character. The character set has been allocated to the buttons as follows

1	1 (space)	.	,	!	?	:	'	"	(	)	%
	&										
2	A	B	C	2	Ä	ä					
3	D	E	F	3	É						
4	G	H	I	4	ì						
5	J	K	L	5							
6	M	N	O	6	Ñ	ö	ò				
7	P	Q	R	7	ß						
8	T	U	V	8	ü	ù					
9	W	X	Y	9							
0	0	+	-	x	*	/	=	>	<		
	#	@									

### Moving the input cursor

When you enter characters using different buttons, the input cursor will move one space to the right automatically. If two or more characters must be entered in succession using the same button, the input cursor must be moved manually.

- ⇨ Press **</>** to move the input cursor.

### Deleting entries

If you have entered an incorrect letters or numbers,

- ⇨ press **CLR** as often as necessary.

### Adding characters

You can add characters to existing text.

- ⇨ Press **</>** to move the input cursor.
- ⇨ Add another character using the buttons **0 - 9**.

### Storing names / telephone numbers

- ⇨ Press **OK** in the telephone mode.

The DSC menu will appear in the display. The cursor **▶** will mark **Setup**.

- ⇨ Press **▼** to select **Phone book**.
- ⇨ Press **OK**.

The menu will appear in the display. The cursor **▶** will mark **Find name**.

- ⇨ Press **▼** to select **Add entry**.
- ⇨ Press **OK**.

The **ADD ENTRY** menu will appear in the display.

- ⇨ Press **▼** to choose between the Radio-phone memory and the SIM card memory.

- ⇨ Press **OK**.

- ⇨ Enter the phone number with the buttons **0 - 9**.

- ⇨ Press **OK**.

- ⇨ Enter the name with the buttons **0 - 9**.

### Note:

The length of the phone book names entries depends on the SIM card (usually 16 characters). The phone number can have up to 20 digits.

- ⇨ Press **OK**.

You will be required to enter a memory number for the entry.

- ⇨ Enter a memory number with the buttons **0 - 9** or

- ⇨ Press **OK** to allocate the number automatically.

You will return to the **ADD ENTRY** menu.

## Finding entries

You can search for entries in the phone book by either name or memory number.

⇨ Press **MEM** in the telephone mode.

The menu will appear in the display. The cursor ► will mark **Find name**.

⇨ Press **Y** to select **Find name** or **Find pos**.

⇨ Press **OK**.

The menu selected, either **FIND ENTRY BY NAME** or **FIND ENTRY BY POSITION**, will appear in the display.

⇨ Use the buttons **0 - 9** to enter the first three characters of the name or the position number (memory number).

⇨ Press **OK**.

The phone will appear in the display, indicating the entry matching name or number entered in the top line.

If no matching entry is found, the nearest match will appear in the first line.

## Editing entries

### Changing an entry

⇨ Select the entry you would like to change in the phone book as described in the section on "Finding entries".

⇨ Press **OK**.

A menu with the functions **Change**, **Delete**, **Move** and **Copy** will appear in the display.

⇨ Press **Y** to select **Change**.

⇨ Press **OK**.

The name of the entry will appear in the top line, the phone number in the second line.

⇨ Press **</>** to move the cursor in the first line.

⇨ Use the buttons **0 - 9** to make any changes, press **CLR** to delete characters.

⇨ Press **OK** to move to the second line.

⇨ Use the buttons **0 - 9** to make any changes, press **CLR** to delete characters.

⇨ Once you have made all the changes, press **OK**.

You will return to the phone book list.

### Deleting an entry

⇨ Select the entry you would like to delete in the phone book as described in the section on "Finding entries".

⇨ Press **OK**.

A menu with the functions **Change**, **Delete**, **Move** and **Copy** will appear in the display.

⇨ Press **Y** to select **Delete**.

⇨ Press **OK**.

The entry will be deleted. You will return to the phone book list.

### Moving an entry in the phone book

⇨ Select the entry you would like to move in the phone book as described in the section on "Finding entries".

⇨ Press **OK**.

A menu with the functions **Change**, **Delete**, **Move** and **Copy** will appear in the display.

⇨ Press **Y** to select **Move**.

⇨ Press **OK**.

⇨ Press **Y/ X** to move the entry.

⇨ Press **OK**.

The entry will be moved. You will return to the phone book list.

### Copying an entry in the phone book

⇨ Select the entry you would like to move in the phone book as described in the section on "Finding entries".

⇨ Press **OK**.

A menu with the functions **Change**, **Delete**, **Move** and **Copy** will appear in the display.

⇨ Press **Y** to select **Copy**.

⇨ Press **OK**.

- ⇨ Press **↵/ √** to move the entry to the position in which you want to copy it.
  - ⇨ Press **OK**.
- The entry will be copied. You will return to the phone book list.

## Capacity query

- ⇨ Press **OK** in the telephone mode.
- ⇨ Press **√** to select **Phone book**.
- ⇨ Press **OK**.
- ⇨ Press **√** to select **Capacity**.
- ⇨ Press **√** to select **SIM card** or **Phone**.
- ⇨ Press **OK**.

The number of memory positions available will appear briefly in the display. Then the phone book menu will appear.

## Locking/unlocking access to the phone book

You can lock the phone book memory of the Radiophone itself, of the SIM card or both.

### Locking the phone book

- ⇨ Press **OK** in the telephone mode.
- ⇨ Press **√** to select **Phone book**.
- ⇨ Press **OK**.
- ⇨ Press **√** to select **Access**.
- ⇨ Press **√** to select **Phone**, **SIM card** or **All**.
- ⇨ Press **OK**.
- ⇨ Enter the access code with the buttons **0 - 9**.
- ⇨ Press **OK**.

### Unlocking the phone book

- ⇨ Proceed as described under "Locking the phone book".
- ⇨ Select the menu item **No locks**.
- ⇨ Press **OK**.
- ⇨ Enter the access code with the buttons **0 - 9**.
- ⇨ Press **OK**.

## Entering your own phone number

You can enter up to three phone numbers for yourself and the mailbox number.

- ⇨ Press **OK** in the telephone mode.

The DSC menu will appear in the display. The cursor **▶** will mark **Setup**.

- ⇨ Press **OK**.
- ⇨ Press **√** to select **My number**.
- ⇨ Press **√** to select **Number 1...3** or **Mailbox**.
- ⇨ Press **OK**.
- ⇨ Use buttons **0 - 9** to enter the corresponding number.
- ⇨ Press **OK**.
- ⇨ Use buttons **0 - 9** to enter the corresponding name.
- ⇨ Press **OK**.

## Messages (SMS) / Mailbox

You can send and receive SMS messages with your Radiophone.

### Reading new messages

New messages are indicated in the display with a  symbol. When a new message is received you will hear a beep.

When you have received a new message,

⇨ press **SMS**.

The message will appear in the display.

To “page through” the messages,

⇨ press **▼/▲**.

If you want to place a call to the sender,

⇨ press .

Once you have read the message,

⇨ press **CLR**.

A selection will appear in the display. You can choose whether you want to delete the message or store it in the memory.

⇨ Press **▼/▲** to select the corresponding option.

⇨ Press **OK**.

If you select **No**, the message will be put into storage.

### Sending messages

⇨ Press **OK** in the telephone mode.

The DSC menu will appear in the display. The cursor  will mark **Setup**.

⇨ Press **▼** to select **Menu**.

⇨ Press **OK**.

The menu will appear in the display. The cursor  will mark **Mailbox**.

⇨ Press **▼** to select **Messages**.

⇨ Press **OK**.

⇨ Press **▼** to select **Output**.

The **OUTPUT** menu will appear in the display.

⇨ Press **▼** to select **New**.

⇨ Press **OK**.

⇨ Now use the buttons **0 - 9** to enter the message. For more information on how to enter text, refer to “Entering names/ telephone numbers” in the chapter entitled “Phone book”.

### Note:

Message texts can have up to a maximum of 160 characters.

⇨ Press **OK**.

⇨ Use the buttons **0 - 9** to enter the phone number.

⇨ Press **OK**.

⇨ Press **▼/▲** to either send, store or send and store the message.

⇨ Press **OK**.

The message will be sent. You will return to the Message output menu.

### Entering the service number

To be able to send messages, you must first enter your provider’s service number. The service number is usually stored on the SIM card and used automatically.

If you have to enter the service number again or would like to change it,

⇨ press **OK** in the telephone mode.

⇨ Press **▼** to select **Menu**.

⇨ Press **OK**.

⇨ Press **▼** to select **Messages**.

⇨ Press **OK**.

⇨ Press **▼** to select **Parameters**.

⇨ Press **OK**.

⇨ Press **▼** to select **Service no**.

⇨ Press **OK**.

⇨ Enter the service number with the buttons **0 - 9**.

⇨ Press **OK**.

The **PARAMETERS** menu will appear in the display.

## Setting message validity

You can select a setting to determine how long the Service Center should try and send the message to its recipient. You can select a time frame of one to seven days.

- ⇨ Press **OK** in the telephone mode.
- ⇨ Press **Y** to select **Menu**.
- ⇨ Press **OK**.
- ⇨ Press **Y** to select **Messages**.
- ⇨ Press **OK**.
- ⇨ Press **Y** to select **Parameters**.
- ⇨ Press **OK**.
- ⇨ Press **Y** to select **Validity**.
- ⇨ Press **OK**.
- ⇨ Enter the number of days with the buttons **0 - 9**.
- ⇨ Press **OK**.

The **PARAMETERS** menu will appear in the display.

## Reading old messages

- ⇨ Press **OK** in the telephone mode.
- ⇨ Press **Y** to select **Menu**.
- ⇨ Press **OK**.
- ⇨ Press **Y** to select **Messages**.
- ⇨ Press **OK**.
- ⇨ Press **Y** to select **Storage**.

The **Storage** with prepared and sent messages will appear in the display. The messages received will indicate the date, time and sender's number.

- ⇨ Press **Y/A** to select the desired message.
- ⇨ Press **OK**.

If you want to place a call to the sender,

- ⇨ press .

Once you have read the message,

- ⇨ press **CLR**.

A selection will appear in the display. You can choose whether or not to delete the message.

- ⇨ Press **Y/A** with the desired option.
- ⇨ Press **OK**.

## Deleting messages

You can delete messages directly after you have read them.

Once you have read the message,

- ⇨ press **CLR**.

A selection will appear in the display. You can choose whether or not to delete the message.

- ⇨ Press **Y/A** to select **Yes**.
- ⇨ Press **OK**.

### Note:

If you want to delete an old message, you have to retrieve it first as described under "Reading old messages".

## Mailbox (Mobile box)

The mailbox (also known as Mobile box) is an answering machine made available to you by your provider. To use the mailbox, you have to enter the mailbox number. You can obtain the mailbox number from your provider.

So that any incoming calls you miss are forwarded to the mailbox, you have to set up call forwarding for the mailbox. For information on setting up call forwarding and the instructions, refer to the section on "Call forwarding" in the chapter on "Using the telephone".

## Entering the mailbox phone number / calling the mailbox

- ⇨ Press **OK** in the telephone mode.
- ⇨ Press **Y** to select **Menu**.
- ⇨ Press **OK**.

The menu will appear in the display. The cursor  will mark **Mailbox**.

- ⇨ Press **OK**.

If no number has been entered as yet,

- ⇨ enter the mailbox number with the buttons **0 - 9**.

- ⇨ Press **OK**.

A call will be placed to your mailbox.

If the mailbox number has already been entered, you will be connected with the mailbox directly once you select the menu item **Mailbox**.

For more information on the mailbox and how to use your mailbox, please contact your provider.

### Cell broadcast messages

Cell broadcast is a regional short message service available from your provider. These short messages are broadcast in numbered channels.

Your provider can supply you with other information such as a list of the channels and categories as well as the charges involved.

If you want to use Cell Broadcast,

- ⇨ press **OK** in the telephone mode.

- ⇨ Press **Y** to select **Menu**.

- ⇨ Press **OK**.

- ⇨ Press **Y** to select **Messages**.

- ⇨ Press **OK**.

- ⇨ Press **Y** to select **Broadcast**.

- ⇨ Press **OK**.

- ⇨ Press **Y** to select **On**.

- ⇨ Press **OK**.

- ⇨ Enter the number of the channel you want to use with the buttons **0 - 9**.

- ⇨ Press **OK**.

The **MESSAGES** menu will appear in the display.

## Special functions

### Determining the user group

User group is a function that is available from your provider.

With "user group", the telephone can be used by a limited group of people only.

#### Note:

Please contact your provider to set up the user groups.

### Switching user group on/off

- ⇨ Press **OK** in the telephone mode.

- ⇨ Press **Y** to select **Menu**.

- ⇨ Press **OK**.

- ⇨ Press **Y** to select **User group**.

- ⇨ Press **OK**.

- ⇨ Press **Y** to select whether the calls can be placed within a special group only (**Group only**) or in a group with a special **Index**.

- ⇨ Press **OK**.

- ⇨ Use with the buttons **0 - 9** to enter the access code for the group, if required.

- ⇨ Press **OK**.

The **USER GROUP** menu will appear in the display.

### Entering AOC parameters

With a SIM card that supports AOC (Advice of Charge), you can enter a charges rate and a credit amount. When the credit has been used up, it can be refilled by an authorised holder of the phone access code or the PIN2.

- ⇨ Press **OK** in the telephone mode.

The DSC menu will appear in the display. The cursor **▶** will mark **Setup**.

- ⇨ Press **OK**.

- ⇨ Press **Y** to select **AOC param**.



- ◇ Press **OK**.
- ◇ Use the buttons **0 - 9** to enter the phone access code or PIN2.
- ◇ Press **Y** to select between **Charge** to have the charges per unit indicated and the input of a **Credit**.
- ◇ Press **OK**.
- ◇ Use the buttons **0 - 9** to enter your settings.
- ◇ Press **OK**.

The **AOC PARAMETERS** menu will appear in the display.

## Specifications

### Amplifier

Output power: 4 x 23 watts RMS according to DIN 45 324 at 14.4 V  
4 x 35 watts max. power

### Tuner

Wavebands:  
FM 87.5 – 108 MHz  
MW 531 – 1 602 kHz  
LW 153 – 279 kHz

FM sensitivity: 0.9  $\mu$ V at 26 dB Signal/Noise ratio

FM frequency range: 30 - 16 000 Hz

### Telephone

Standard: GSM

Frequency band:  
Transmit 890 – 915 MHz  
Receive 935 – 960 MHz

Transmission power: Class 2 / 8 watts

Sensitivity: -108 dBm

Impedance:  
Antenna connection 50 ohms  
Hands-free microphone 660 ohms

## REMOTE CONTROL (OPTIONAL)

### Operating the Radiophone with the RCT 07 remote control unit (optional)

With the optional RCT 07 remote control unit, you can operate the most important functions of the Antares T 60 conveniently and safely from the steering wheel.

#### Radio operation

-  Activates the telephone mode
- V-** Decreases the volume
- V+** Increases the volume
- TA** Switching traffic radio standby on/off
- ↗** Seek tuning up, moves cursor in lists
- ↘** Seek tuning down, moves the cursor in lists
- SRC** Source switch between radio, CD changer (optional) or an auxiliary audio source (AUX)
- ME** Retrieves the station list and makes selections in the station list

#### Telephone operation

-  Retrieves the list of calls dialled last  
Places a call to the number in the display
- V-** Decreases the volume
- V+** Increases the volume
- TA** Switches traffic radio standby on/off
- ↗** Retrieves the list of calls received, moves cursor in lists
- ↘** Retrieves the list of missed calls, moves the cursor in lists
- SRC** Returns to the audio source activated last
- ME** Press briefly: Retrieves the phone book, sorted alphabetically.  
Press long: Retrieves the phone book, sorted numerically

#### CD changer operation (optional)

-  Activates the telephone mode
- V-** Decreases the volume
- V+** Increases the volume
- TA** Switches traffic radio standby on/off
- ↗** Plays next track, moves cursor in lists
- ↘** Plays previous track, restarts the current track, moves the cursor in lists
- SRC** Source switch to radio
- ME** Retrieves the CD list and makes selections in the CD list



## DSC menu - Telephone

- Setup
- Menu
- Phone book

select with  
back with  
back to radio

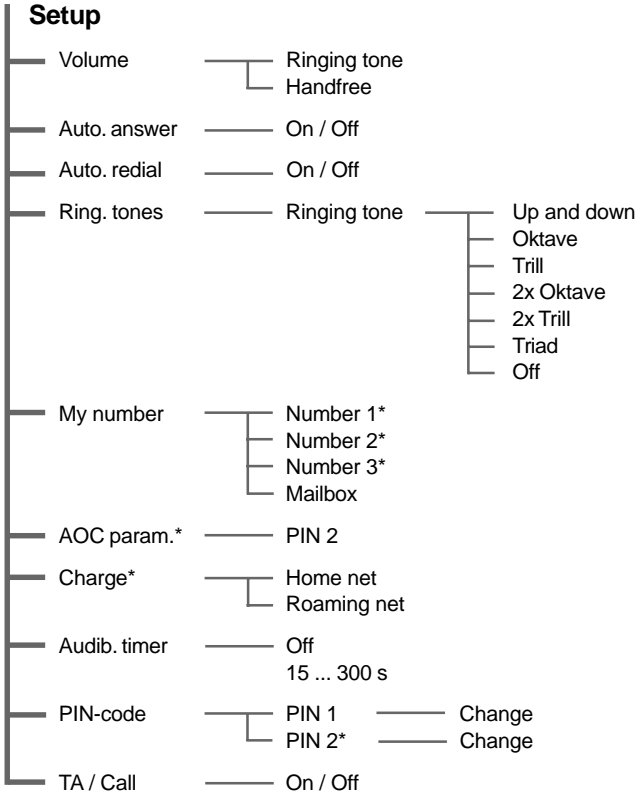

\* Display of the menu item depends on the SIM card used.

# TELEPHONE MENU OVERVIEW



## DSC menu - Telephone

- Setup
- Menu**
- Phone book

select with  
back with  
back to radio

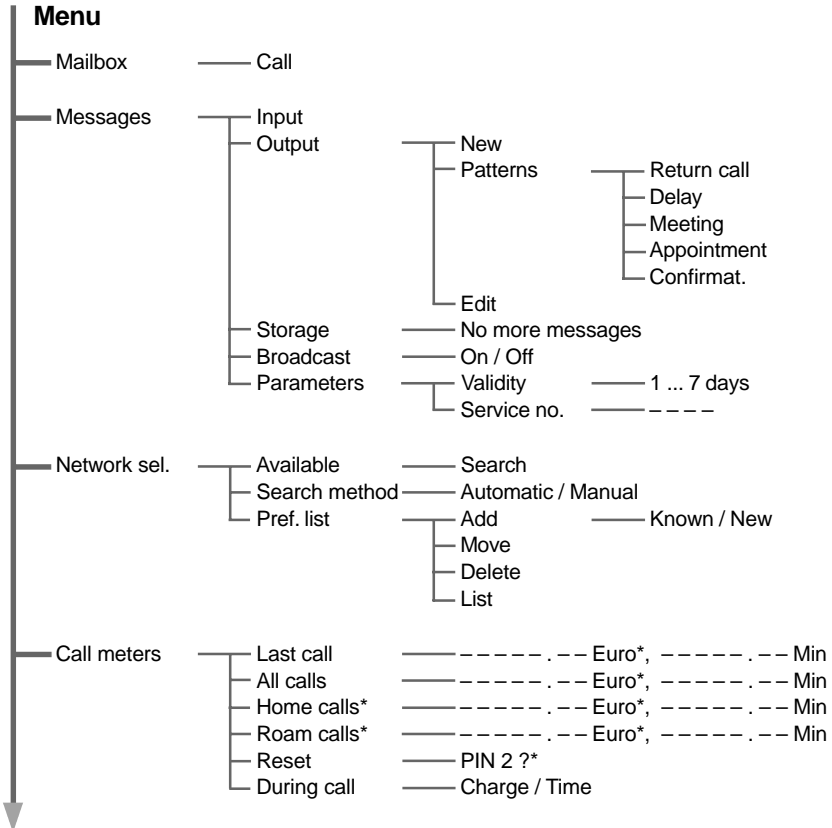

\* Display of the menu item depends on the SIM card used.

# TELEPHONE MENU OVERVIEW

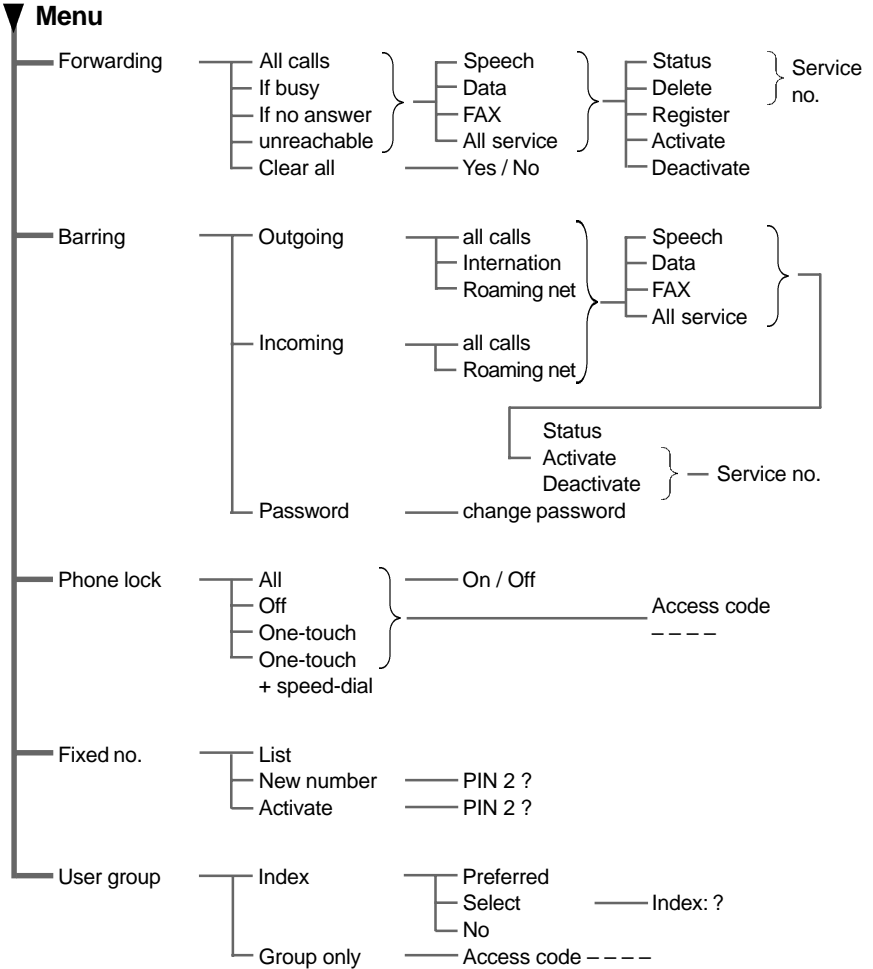

\* Display of the menu item depends on the SIM card used.

# TELEPHONE MENU OVERVIEW



## DSC menu - Telephone

Setup

Menu

Phone book

select with

back with

back to radio



CLR

SRC

### Phone book

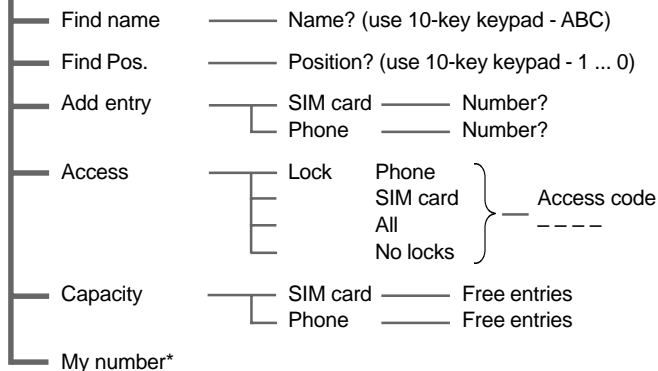

\* Display of the menu item depends on the SIM card used.

**SRC**  
**OK**

## DSC menu – Radio

Setup  
Radio

select with



back with

**CLR**

back to radio

**SRC**

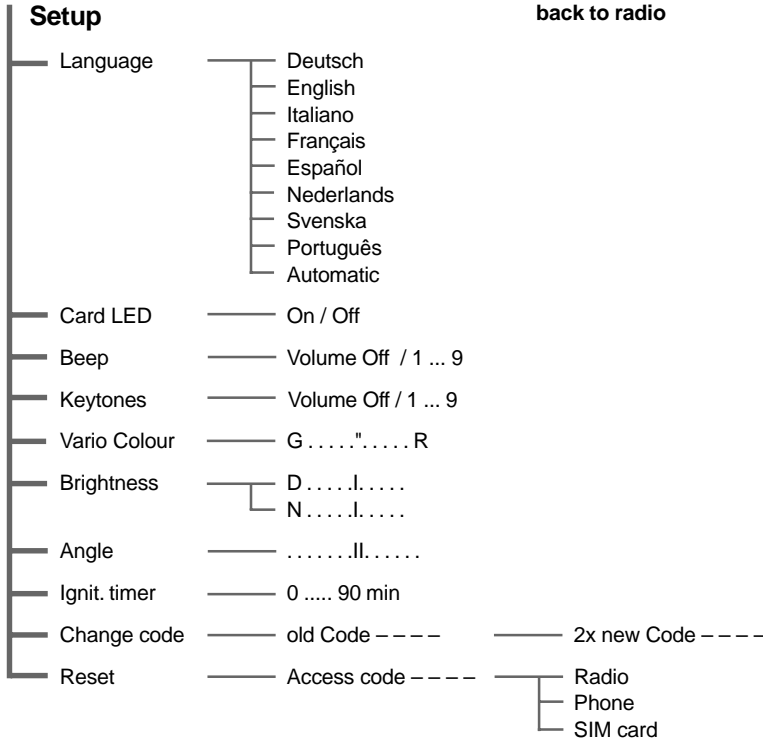

## SRC OK DSC menu - Radio

Setup  
Radio

select with



back with

CLR

back to radio

SRC

Radio	
Radiotext	Off / On / On/Eng. off
Loudness	Level 1 ... 6
TA volume	Level 0 ... 63
Volume FIX	Level 0 ... 63
Sensitivity	DX Low / Middle / High LO Low / Middle / High
Aux	On / Off
Disc Naming**	Change name Clear name
Music/Speech	Off ... Level 4

---

\*\* if a CD changer is connected



## Glossary of Technical Terms

### Access code

Barred functions can be operated after the access code has been entered.

### Adapter card

Holder for small SIM cards. With the help of an adapter card, it is possible to use small SIM cards in equipment which was otherwise designed for use with standard-sized SIM cards.

### AF - Alternative Frequency

This function enables the equipment to automatically select the best available frequency for the reception of an RDS program.

### Amplifier

Amplifies the output power.

### AOC parameter - Advice of Charge

List of charges in which a charge per unit and a credit balance can be entered.

### AUD - Audio

Tone adjustments for bass and treble, fader (front and rear) and balance (left and right).

### BND (Band)

Switches between wavebands and memory levels.

### Broker's call

It is possible to make a second call without ending the first one. You can then switch from one call to the other.

You can also answer a call from a second party without ending the call to the first.

### Call waiting

A quiet beep during a telephone call informs you that another caller is trying to reach you.

### Cell Broadcast

Cell Broadcast is a short message service which operates in numbered "channels". The channels transmit different special messages.

Request more detailed information and a list of the available channels from your network operator/service provider.

### Changer

CD changer (accessory)

### CLR - Clear (delete)

Returns to previous menu.

### DSC - Direct Software Control

With the help of DSC you can adjust the basic factory settings and functions to your personal needs and to store these settings.

### EON - Enhanced Other Networks

EON is an RDS service which makes it possible to exchange station information within a station broadcasting network. The radio will, for example, automatically switch from a non TA station to a TA station in the same radio network in order to broadcast a traffic announcement. After the traffic announcement has been broadcast, the radio will switch back to the previous network once again.

### GSM network - Global System for Mobile Communication

European cellular telephone standard available world-wide

# GLOSSARY

---

## **Handset**

Telephone receiver complete with cradle (accessory).

## **IMEI - International Mobile Equipment Identity**

International identity for mobile equipment. The IMEI code entered at the factory includes the serial number, manufacturer and country code. You can find this code in the car radio pass.

## **International Roaming**

Making telephone calls in foreign countries with your own telephone or your own SIM card using a different network operator/service provider. There must be a roaming agreement between your service provider and the foreign network.

## **Mailbox**

Electronic mailbox provided by network operators/service providers for spoken messages. The mailbox can be compared to an answering machine.

## **MEM - Memory**

Retrieves stored data, such as radio stations, telephone numbers.

## **MIX**

CDs/CD tracks are played in random order.

## **MUTE**

Switches off the microphone in the telephone mode.

## **PaX - Personal Access**

Allows direct access to a function in radio or CD mode which was previously stored.

## **PIN code - Personal Identification Number**

### **PIN 1**

Prevents your SIM card from being used by unauthorised persons. You must enter the PIN code each time you insert the SIM card.

### **PIN 2**

Code required for special functions.

If you have authorisation for the use of special functions with your card, you need a PIN 2-code.

Both codes come with the SIM card and can be altered.

## **PUK - Personal Unblock Key, Master PIN Code, Super PIN, etc.**

Eight-digit unblock code which can reactivate the SIM card. This becomes necessary if the PIN code for the SIM card has been entered incorrectly three times.

The PUK code comes with the SIM card and cannot be altered. Make sure you keep it in a safe place.

## **Radiotext**

Additional RDS information provided by the station, for example, on the program broadcast.

## **RDS - Radio Data System**

Service provided by radio stations for more convenient radio listening pleasure.

The station name appears in the display, for example, rather than the frequency.

Other RDS functions include:

AF - Alternative Frequency

EON - Enhanced Other Networks

RT - Radiotext

TA - Traffic Announcement

TP - Traffic Program

## **Scrolling**

Moves you through a directory.

## **SIM card - Subscriber Identification Module**

For radio and telephone operation. The SIM card used here is in credit-card format. It is also possible to use the small SIM card (plug-in card) with an adapter card.

The SIM card contains all of the data required to identify the subscriber, to allocate the telephone number and the personal phone book.

## **SMS - Short Message Service**

Using this function it is possible to send other subscribers messages up to 160 characters in length, even if the recipient's cellular phone is not switched on or a call cannot be put through at the present time.

The text is stored in the network until the recipient retrieves it or the time allowed by the sender expires.

## **Speed-dial**

This function allows you to dial telephone numbers at the touch of a button.

## **SRC - Source**

Switches audio source between radio, CD changer and AUX. Returns the system from telephone to radio operation.

## **TA - Traffic Announcement (priority for traffic messages)**

"TA" in the display indicates that traffic announcement priority is switched on.

## **TP - Traffic Program**

"TP" in the display indicates that the radio is currently tuned into a radio station which broadcasts traffic information.

## **TS - Travelstore**

Automatically stores the radio stations with the strongest reception signals, can be retrieved by pressing the station preset buttons. Very useful on trips.

## **User group**

It is possible to limit the use of the telephone to a certain group of users. Your network operator/service provider can provide more detailed information.

# Service numbers

Country:	Phone:	Fax:	WWW:
Germany	(D) 0180-5000225	05121-49 4002	<a href="http://www.blaupunkt.com">http://www.blaupunkt.com</a>
Austria	(A) 01-610 390	01-610 393 91	
Belgium	(B) 02-525 5454	02-525 5263	
Denmark	(DK) 44 898 360	44-898 644	
Finland	(FIN) 09-435 991	09-435 99236	
France	(F) 01-4010 7007	01-4010 7320	
Great Britain	(GB) 01-89583 8880	01-89583 8394	
Greece	(GR) 0800-550 6550	01-576 9473	
Ireland	(IRL) 01-4149400	01-4598830	
Italy	(I) 02-369 6331	02-369 6464	
Luxembourg	(L) 40 4078	40 2085	
Netherland	(NL) 023-565 6348	023-565 6331	
Norway	(N) 66-817 000	66-817 157	
Portugal	(P) 01-2185 00144	01-2185 11111	
Spain	(E) 902-120234	916-467952	
Sweden	(S) 08-7501500	08-7501810	
Switzerland	(CH) 01-8471644	01-8471650	
Czech. Rep.	(CZ) 02-6130 0441	02-6130 0514	
Hungary	(H) 01-333 9575	01-324 8756	
Poland	(PL) 0800-118922	022-8771260	
Turkey	(TR) 0212-3350677	0212-3460040	
USA	(USA) 800-2662528	708-6817188	
Brasil (Mercosur)	(BR) +55-19 3745 2769	+55-19 3745 2773	
Malaysia (Asia Pacific)	(MAL) +604-6382 474	+604-6413 640	

**Blaupunkt GmbH**

